

AUFLAGESEITE

SENKRECHTER SCHNITT oben

Kunde		ZUANI DEUTSCHLAND rif. PAULI			
Title		Fensterschnitt IV 78/78 - Eurofalz Achsmass 13 mm			
Revis.	A.P.	Date	15-05-2012	Scala	1:1
Verif.	M.Z.	Date	12-12-2011	Dis.	M.Z.
				Codice Dis.N°	A7878D22.96
				Date	12-12-2011

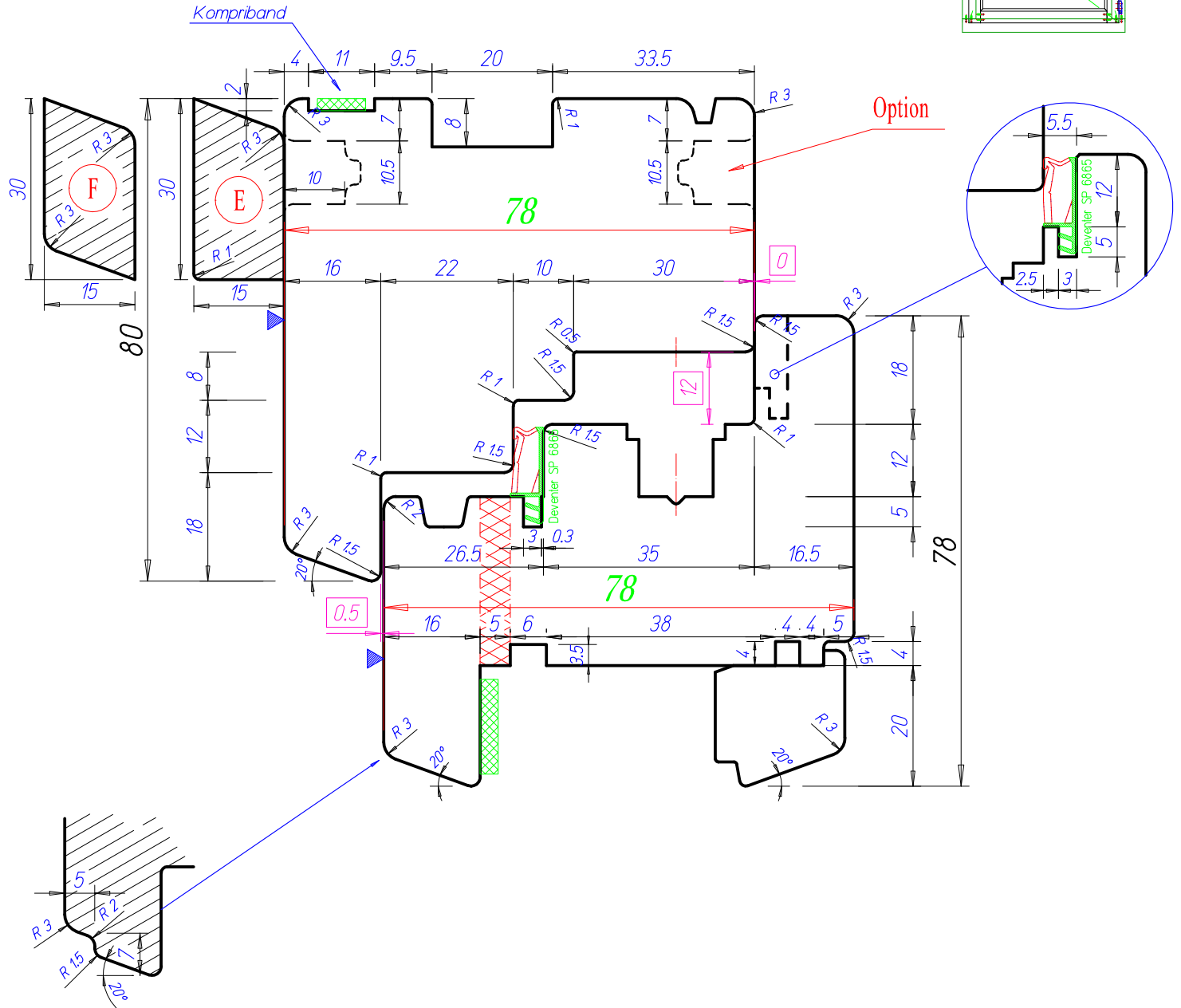
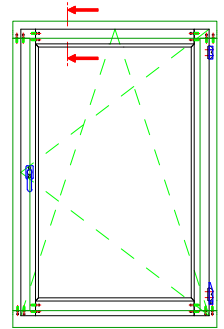

AUFLAGESEITE

SENKRECHTER SCHNITT oben

Kunde		ZUANI DEUTSCHLAND rif. PAULI			
Title		Fensterschnitt IV 78/78 - Eurofalz Achsmass 13 mm			
Revis.	A.P.	Date	15-05-2012	Scala	1:1
Verif.	M.Z.	Date	12-12-2011	Dis.	M.Z.
				Date	12-12-2011
				Codice Dis.N°	A7878D22.96

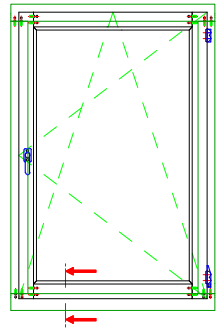

Gutmann
Spree OF 24

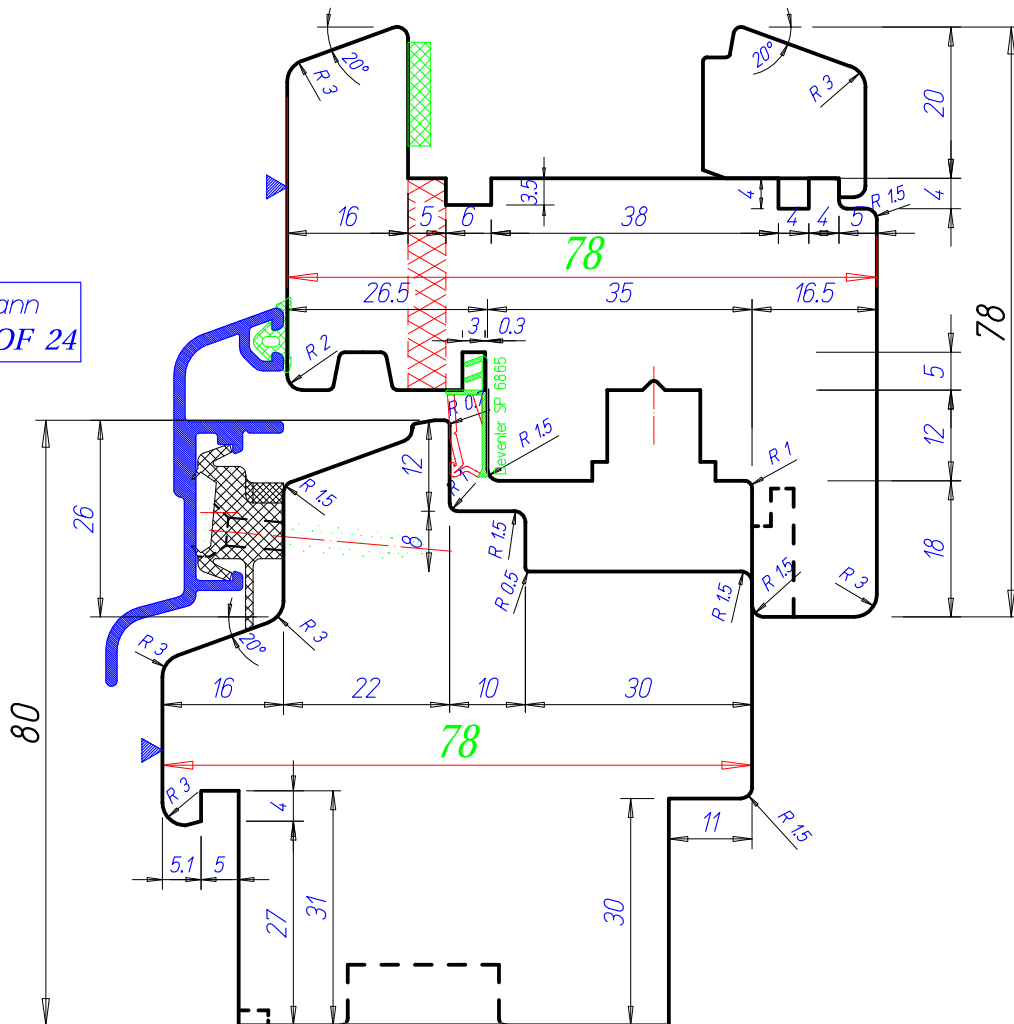

AUFLAGESEITE

SENKRECHTER SCHNITT unten

Kunde		ZUANI DEUTSCHLAND rif. PAULI			
Title		Fensterschnitt IV 78/78 - Eurofalz Achsmass 13 mm			
Revis.	A.P.	Date	15-05-2012	Scala	1:1
Verif.	M.Z.	Date	12-12-2011	Dis.	M.Z.
				Codice Dis.N°	A7878D22.96
				Date	12-12-2011

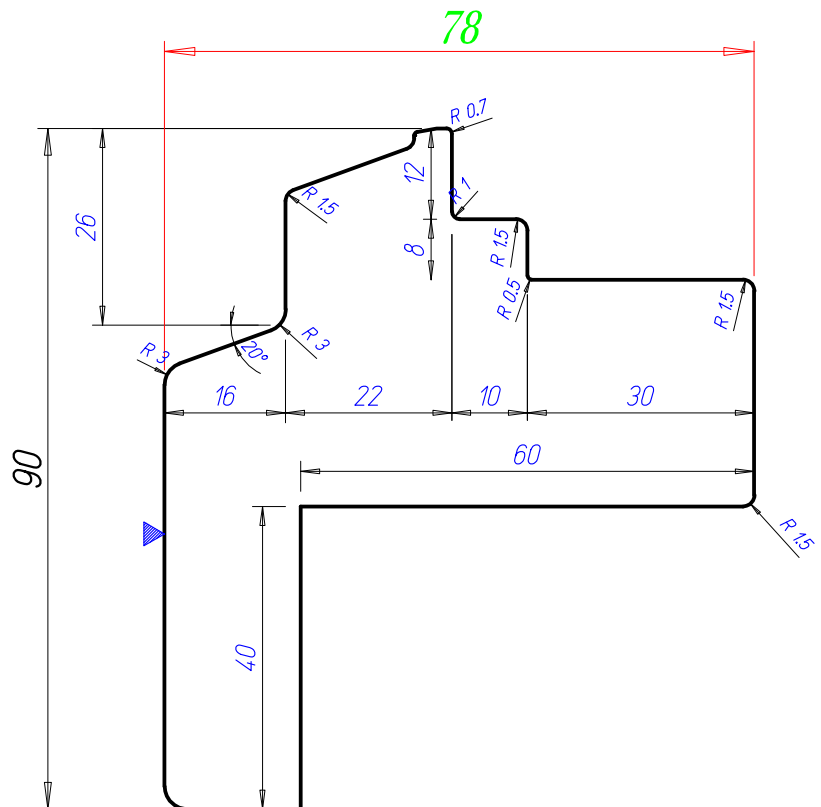
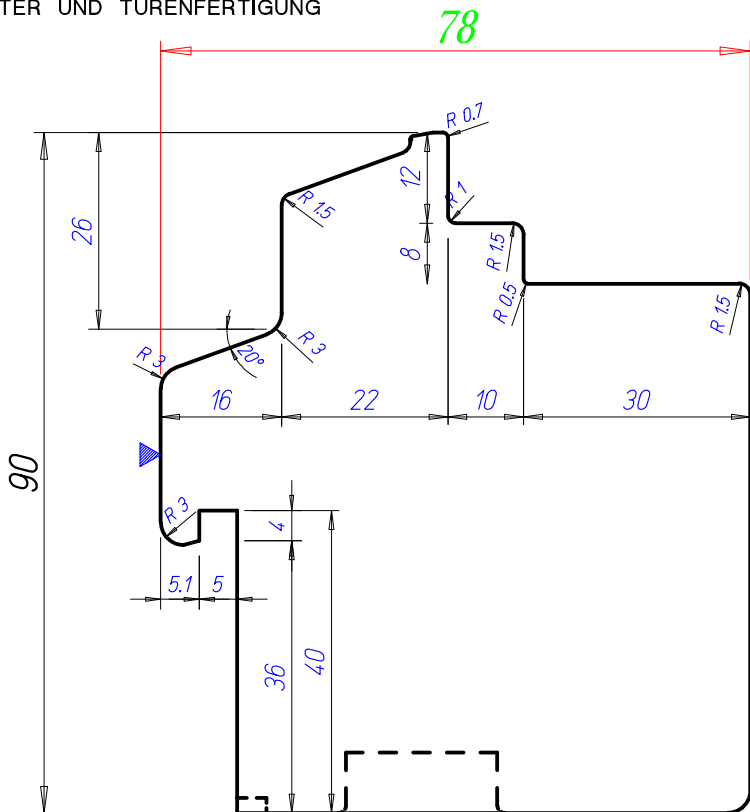
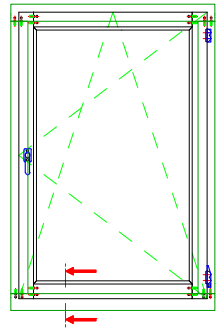

AUFLAGESEITE

SENKRECHTER SCHNITT unten

Kunde		ZUANI DEUTSCHLAND rif. PAULI			
Title Fensterschnitt IV 78/78 - Eurofalz Achsmass 13 mm					
Revis.	A.P.	Date	15-05-2012	Scala	1:1
Verif.	M.Z.	Date	12-12-2011	Dis.	M.Z.
				Date	12-12-2011
				Codice Dis.°	A7878D22.96

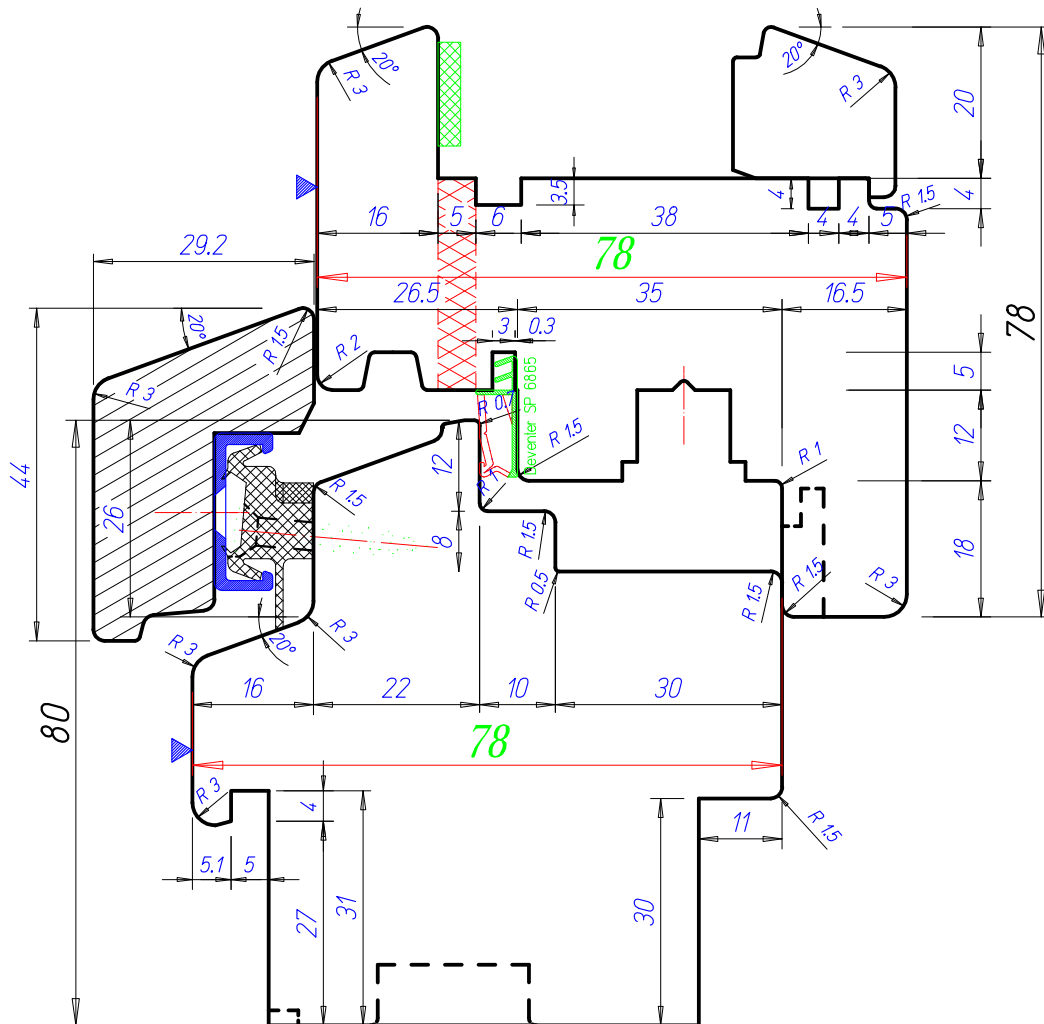
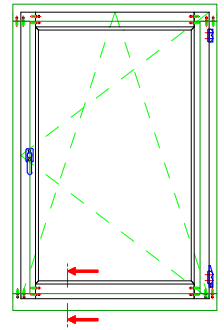

AUFLAGESEITE

SENKRECHTER SCHNITT unten

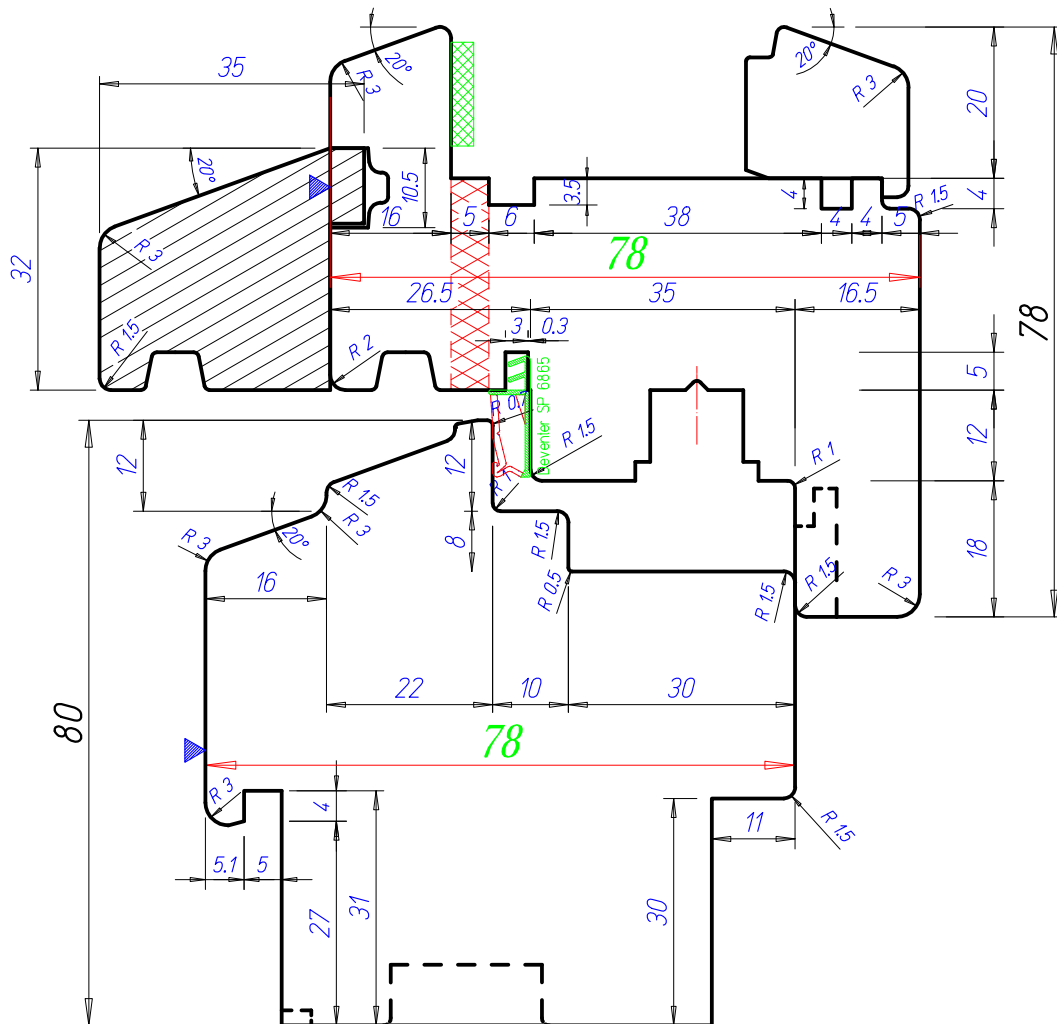
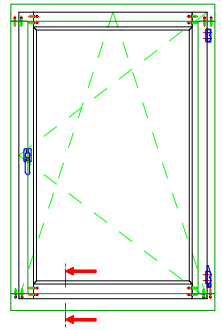

AUFLAGESEITE

SENKRECHTER SCHNITT unten DENKMAL

Kunde		ZUANI DEUTSCHLAND rif. PAULI			
Title		Fensterschnitt IV 78/78 - Eurofalz Achsmass 13 mm			
Revis.	A.P.	Date	15-05-2012	Scala	1:1
Verif.	M.Z.	Date	12-12-2011	Dis.	M.Z.
		Date	12-12-2011	Codice Dis.N°	A7878D22.96

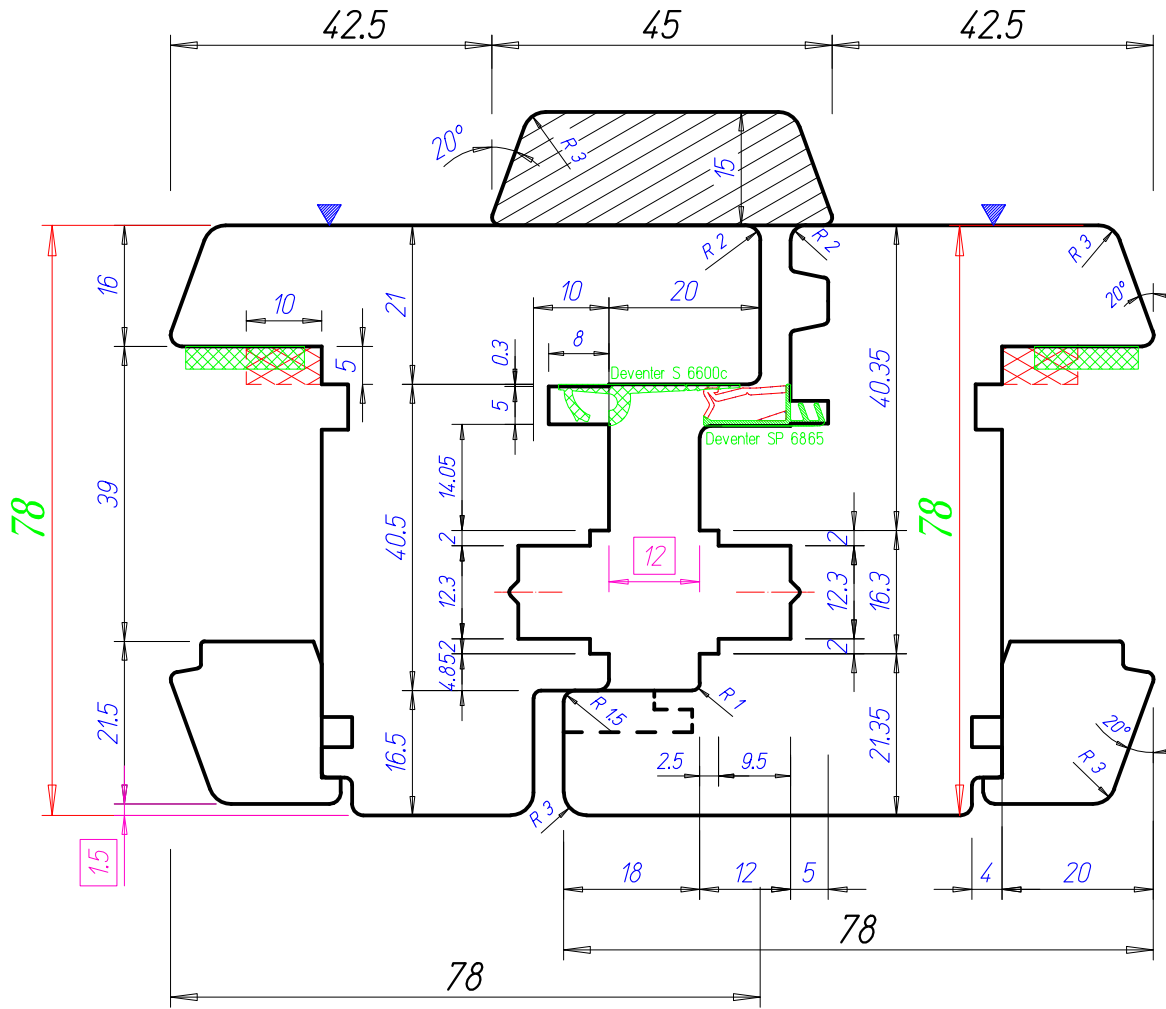
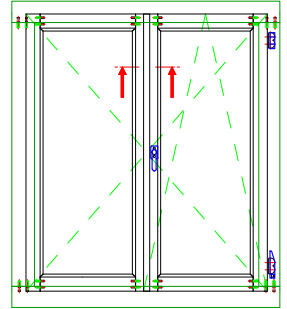

AUFLAGESEITE

WAAGERECHTER SCHNITT - Mittelfalz ohne Überfäzung

Kunde		ZUANI DEUTSCHLAND rif. PAULI			
Title		Fensterschnitt IV 78/78 - Eurofalz Achsmass 13 mm			
Revis.	A.P.	Date	15-05-2012	Scala	1:1
Verif.	M.Z.	Date	12-12-2011	Dis.	M.Z.
		Date	12-12-2011	Codice	
				Dis.N°	A7878D22.96

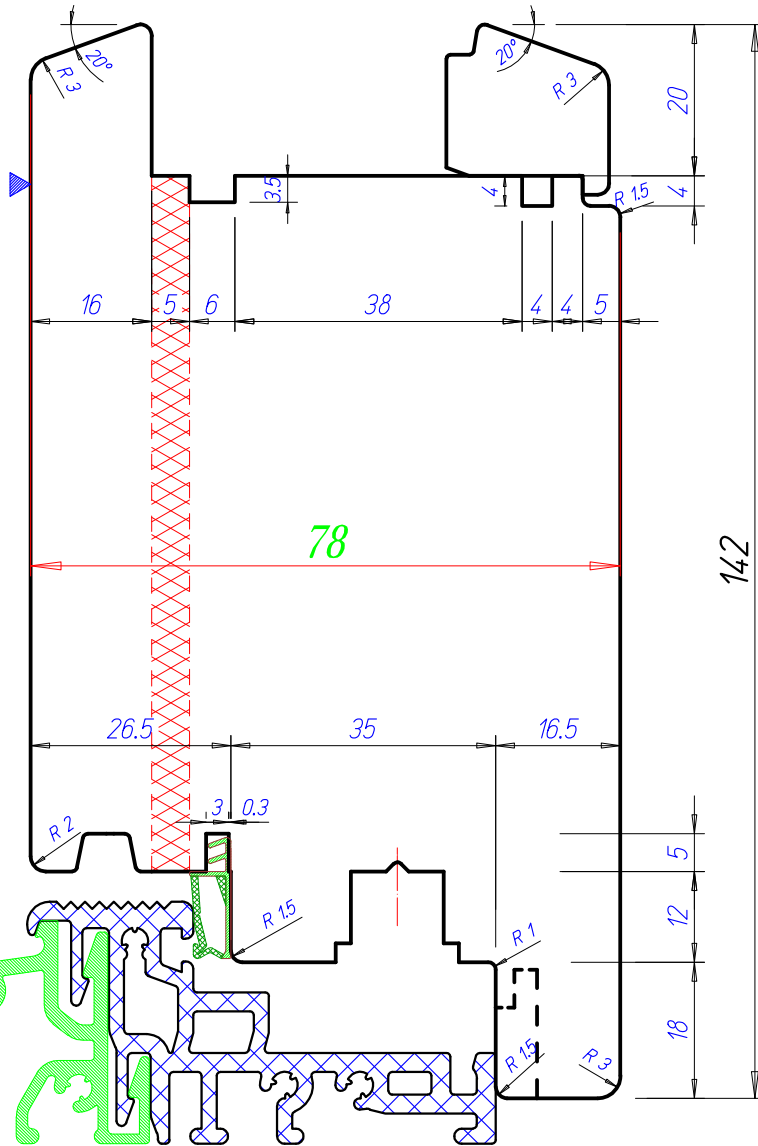
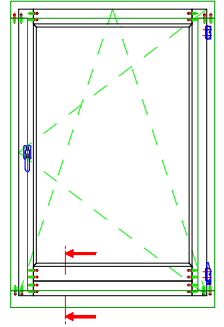

GUTMANN
Weser 84/32 TI

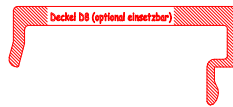
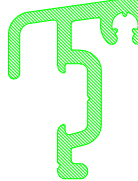

▶ AUFLAGESEITE

BALKONTÜR - SENKRECHTER SCHNITT UNTEN

Kunde		ZUANI DEUTSCHLAND rif. PAULI			
Title		Fensterschnitt IV 78/78 - Eurofalz Achsmass 13 mm			
Revis.	A.P.	Date	15-05-2012	Scala	1:1
Verif.	M.Z.	Date	12-12-2011	Dis.	M.Z.
		Codice	A7878D22.96		
		Dis.N°			

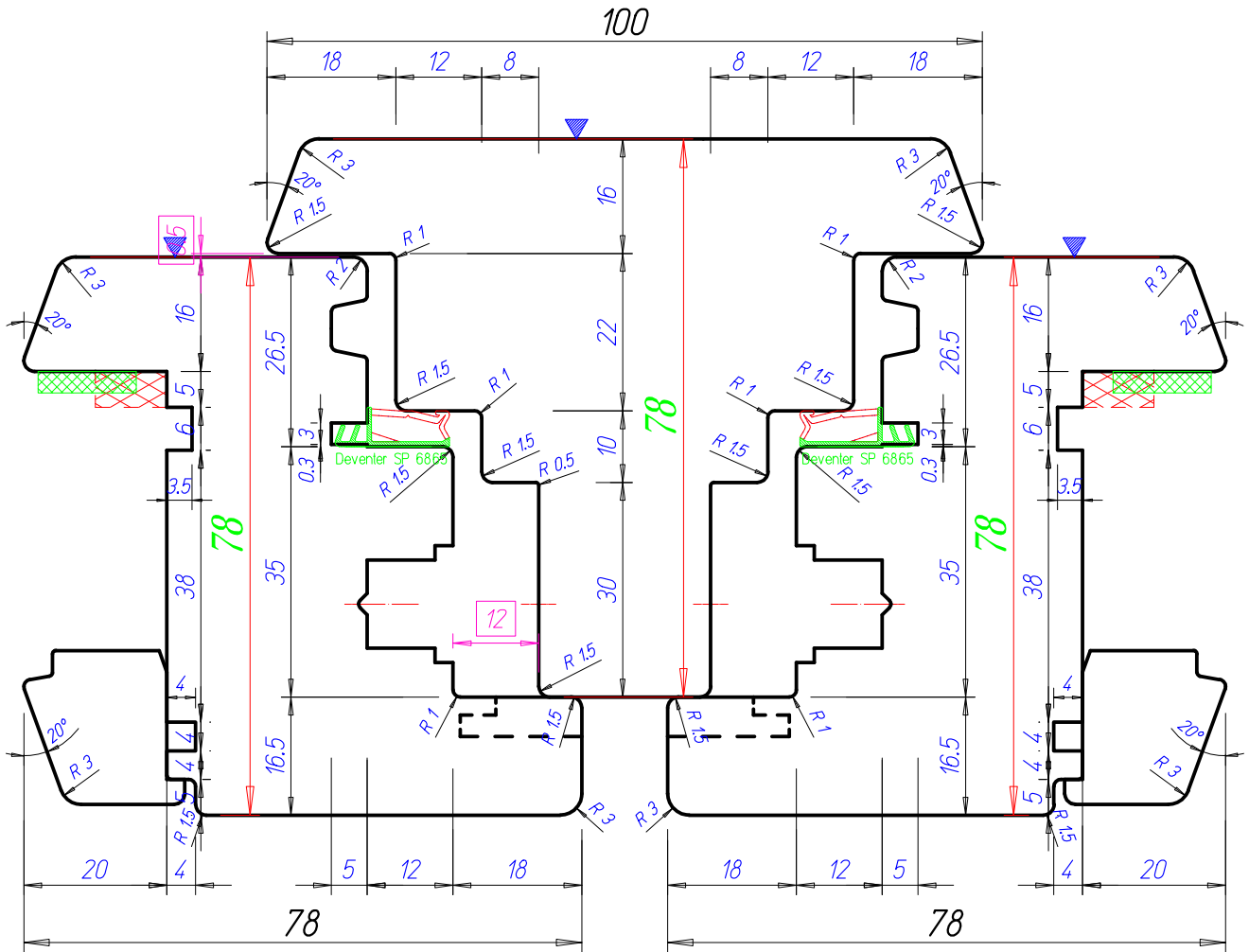
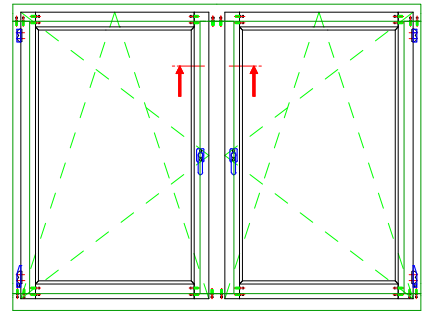

 AUFLAGESEITE

WAAGERECHTER SCHNITT - SETZHOLZ

Kunde		ZUANI DEUTSCHLAND rif. PAULI			
Title		Fensterschnitt IV 78/78 - Eurofalz Achsmass 13 mm			
Revis.	A.P.	Date	15-05-2012	Scala	1:1
Verif.	M.Z.	Date	12-12-2011	Dis.	M.Z.
		Codice Dis.N°	A7878D22.96		

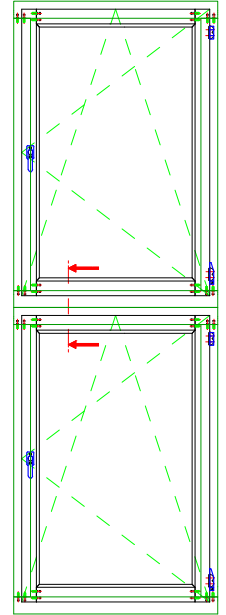

Gutmann
Spree OF 24

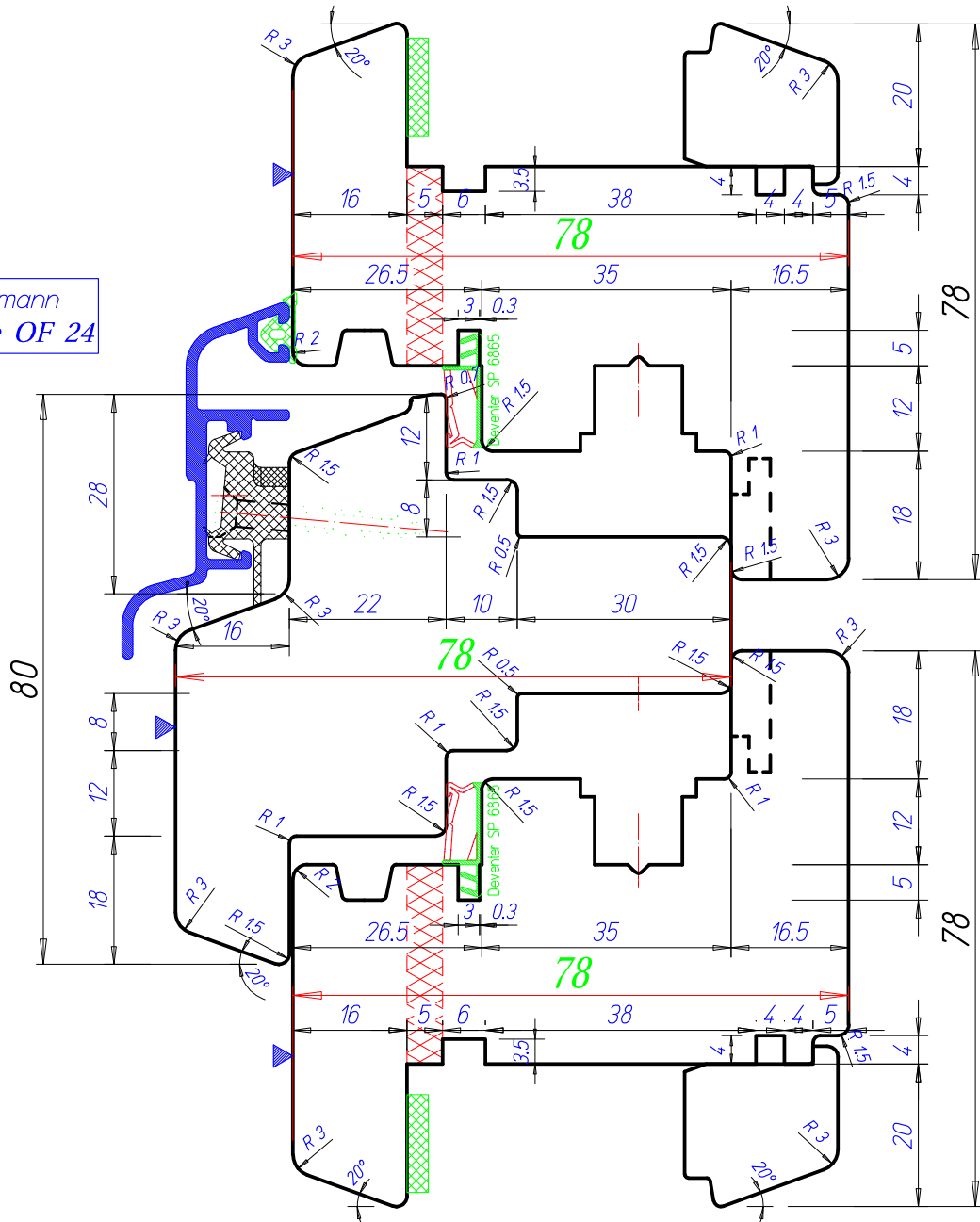

AUFLAGESEITE

SENKRECHTER SCHNITT - KÄMPFER

Kunde		ZUANI DEUTSCHLAND rif. PAULI			
Title		Fensterschnitt IV 78/78 - Eurofalz Achsmass 13 mm			
Revis.	A.P.	Date	15-05-2012	Scala	1:1
Verif.	M.Z.	Date	12-12-2011	Dis.	M.Z.
		Codice Dis.N°	A7878D22.96		

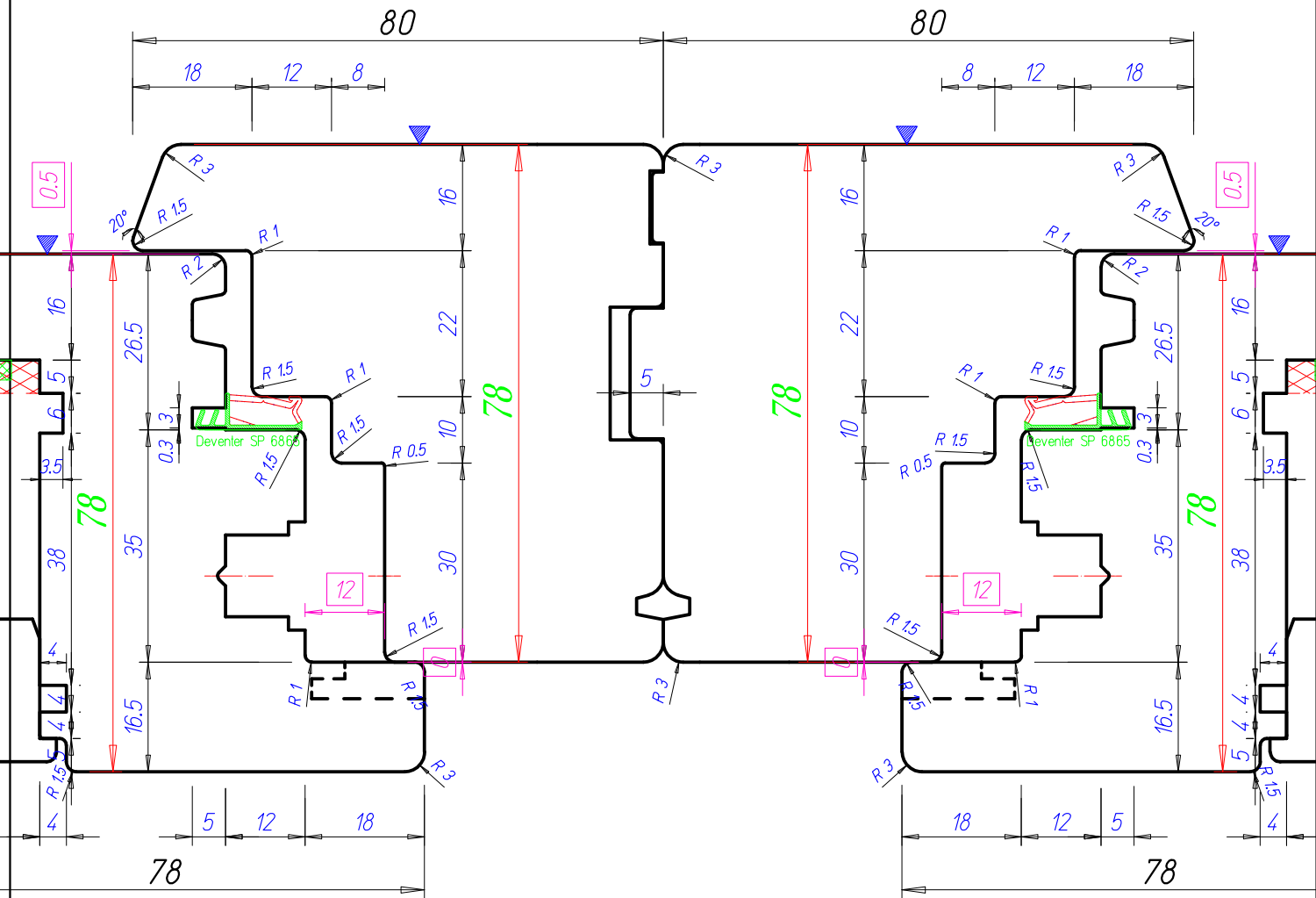
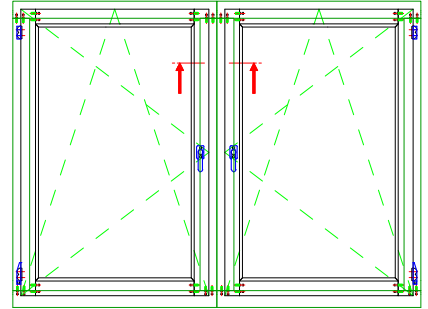

AUFLAGESEITE

WAAGERECHTER SCHNITT - SETZHOZ

Kunde		ZUANI DEUTSCHLAND rif. PAULI			
Title		Fensterschnitt IV 78/78 - Eurofalz Achsmass 13 mm			
Revis.	A.P.	Date	15-05-2012	Scala	1:1
Verif.	M.Z.	Date	12-12-2011	Dis.	M.Z.
				Date	12-12-2011
				Codice	A7878D22.96
				Dis.N°	

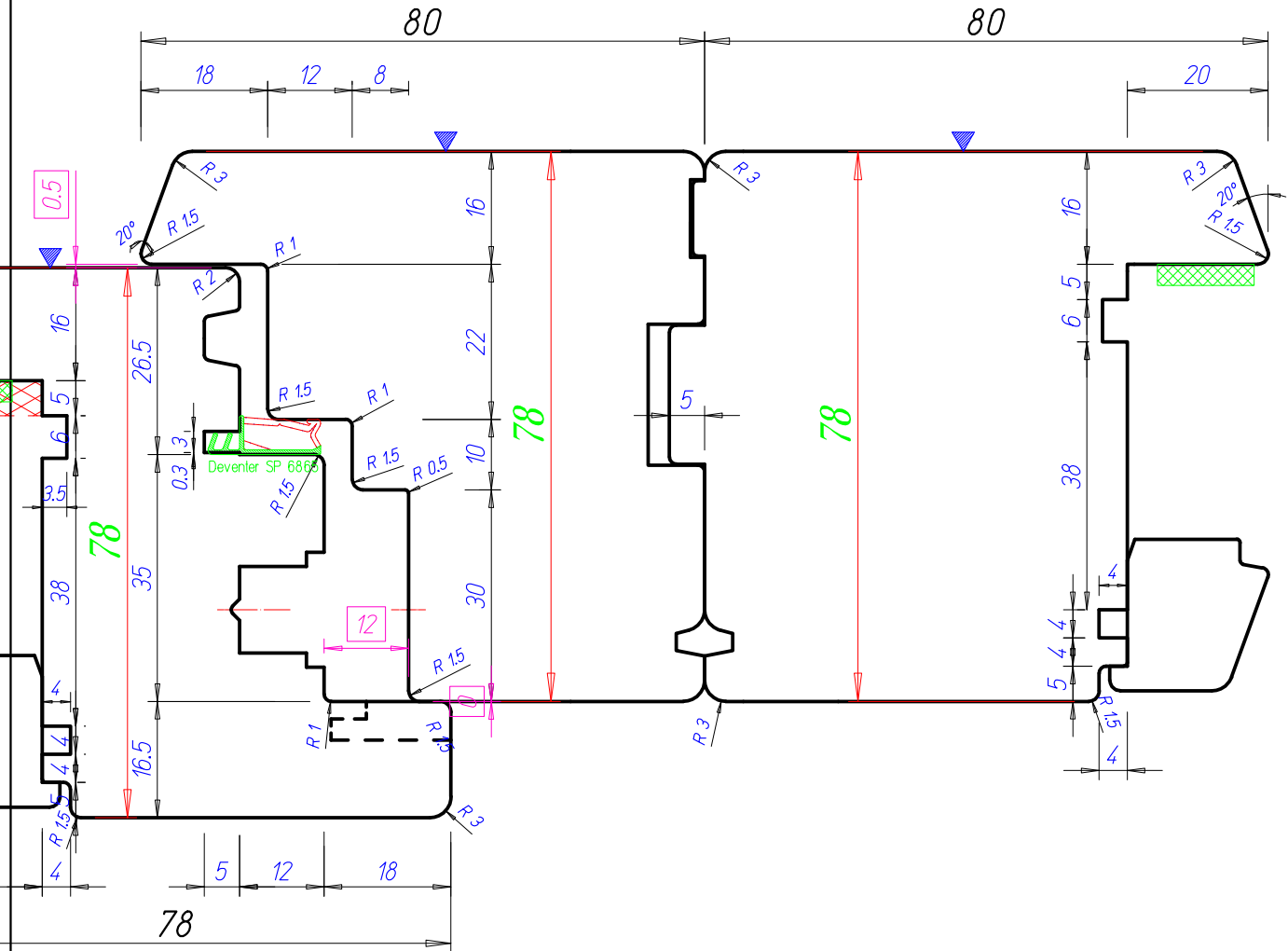
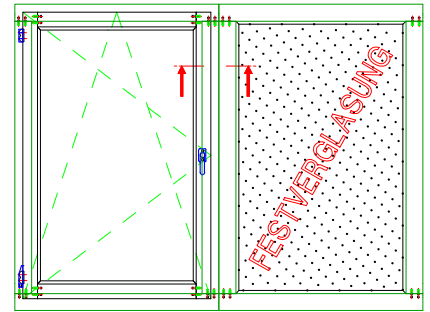

AUFLAGESEITE

WAAGERECHTER SCHNITT - SETZHOLZ

Kunde		ZUANI DEUTSCHLAND rif. PAULI			
Title		Fensterschnitt IV 78/78 - Eurofalz Achsmass 13 mm			
Revis.	A.P.	Date	15-05-2012	Scala	1:1
Verif.	M.Z.	Date	12-12-2011	Dis.	M.Z.
				Codice Dis.N°	A7878D22.96
				Date	12-12-2011

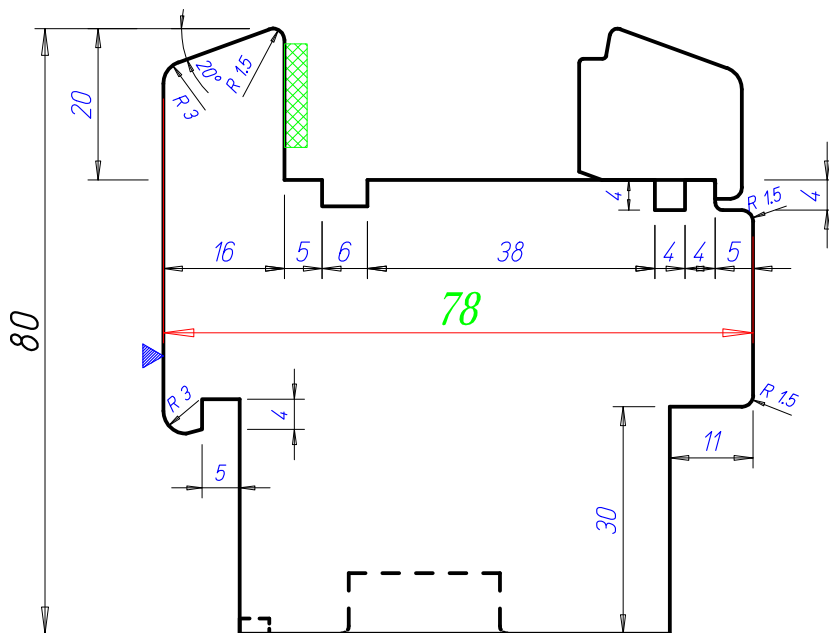
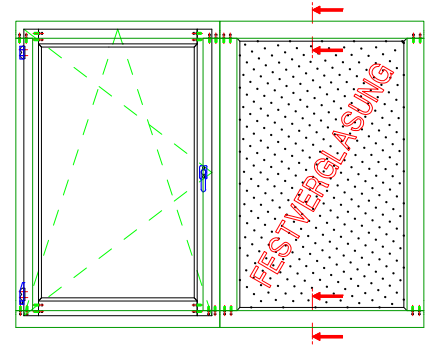
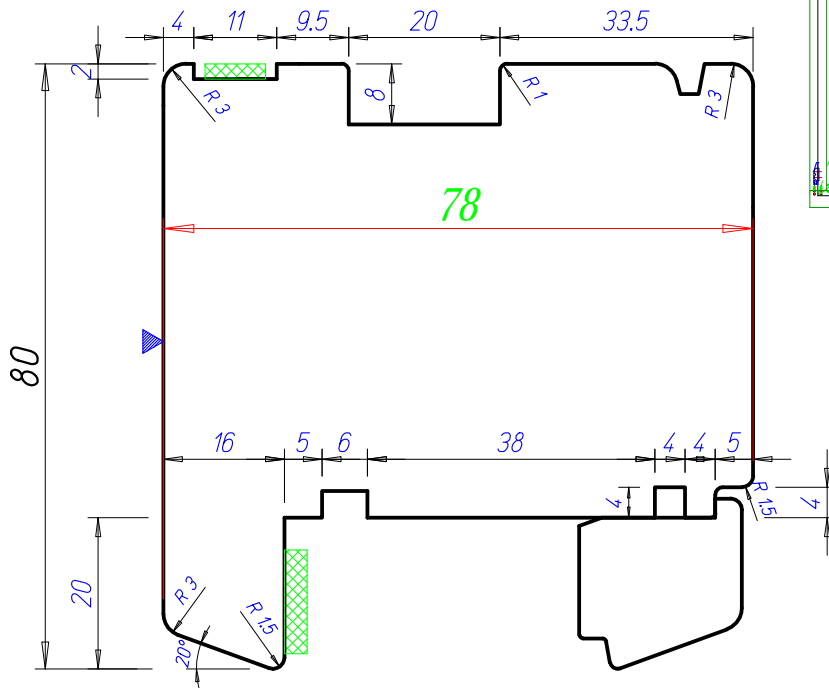

 AUFLAGESEITE

SENKRECHTER SCHNITT - SETZHOLZ

Kunde		ZUANI DEUTSCHLAND rif. PAULI			
Title		Fensterschnitt IV 78/78 - Eurofalz Achsmass 13 mm			
Revis.	A.P.	Date	15-05-2012	Scala	1:1
Verif.	M.Z.	Date	12-12-2011	Dis.	M.Z.
				Codice Dis.N°	A7878D22.96
				Date	12-12-2011

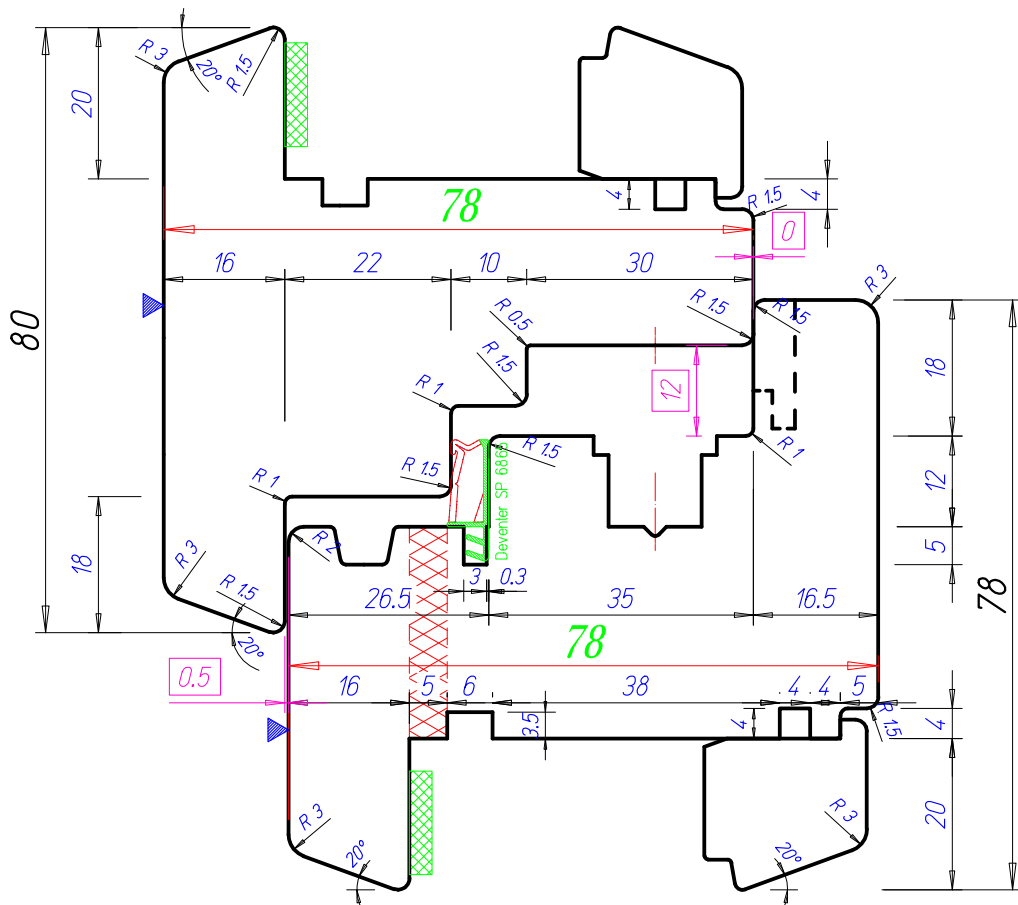
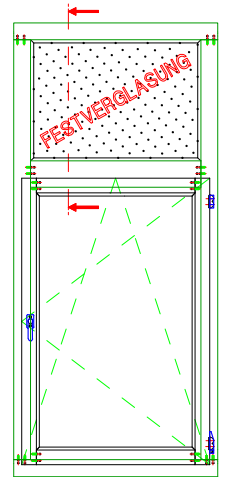
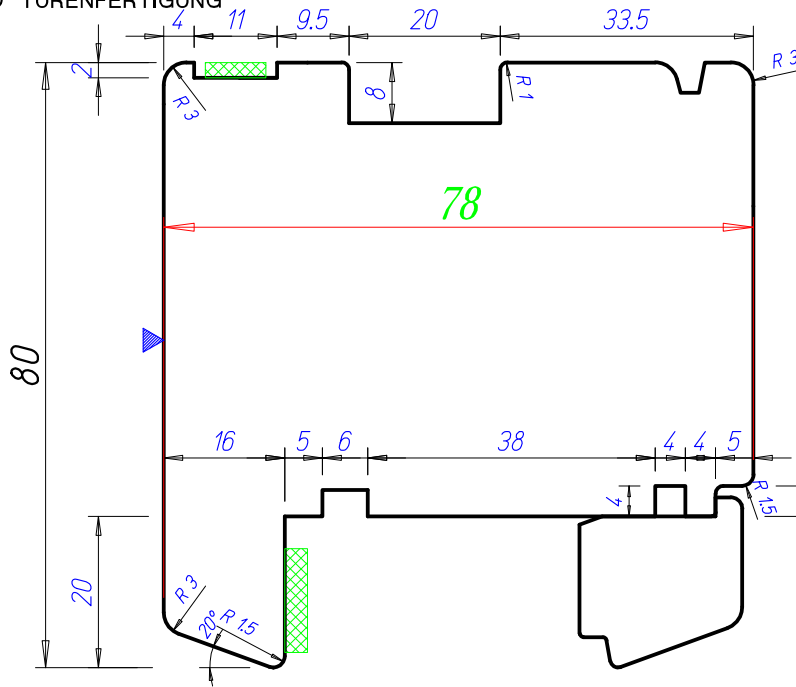

AUFLAGESEITE

SENKRECHTER SCHNITT - ÜBERLICHT

Kunde		ZUANI DEUTSCHLAND rif. PAULI			
Title		Fensterschnitt IV 78/78 - Eurofalz Achsmass 13 mm			
Revis.	A.P.	Date	15-05-2012	Scala	1:1
Verif.	M.Z.	Date	12-12-2011	Dis.	M.Z.
				Codice Dis.N°	A7878D22.96
				Date	12-12-2011

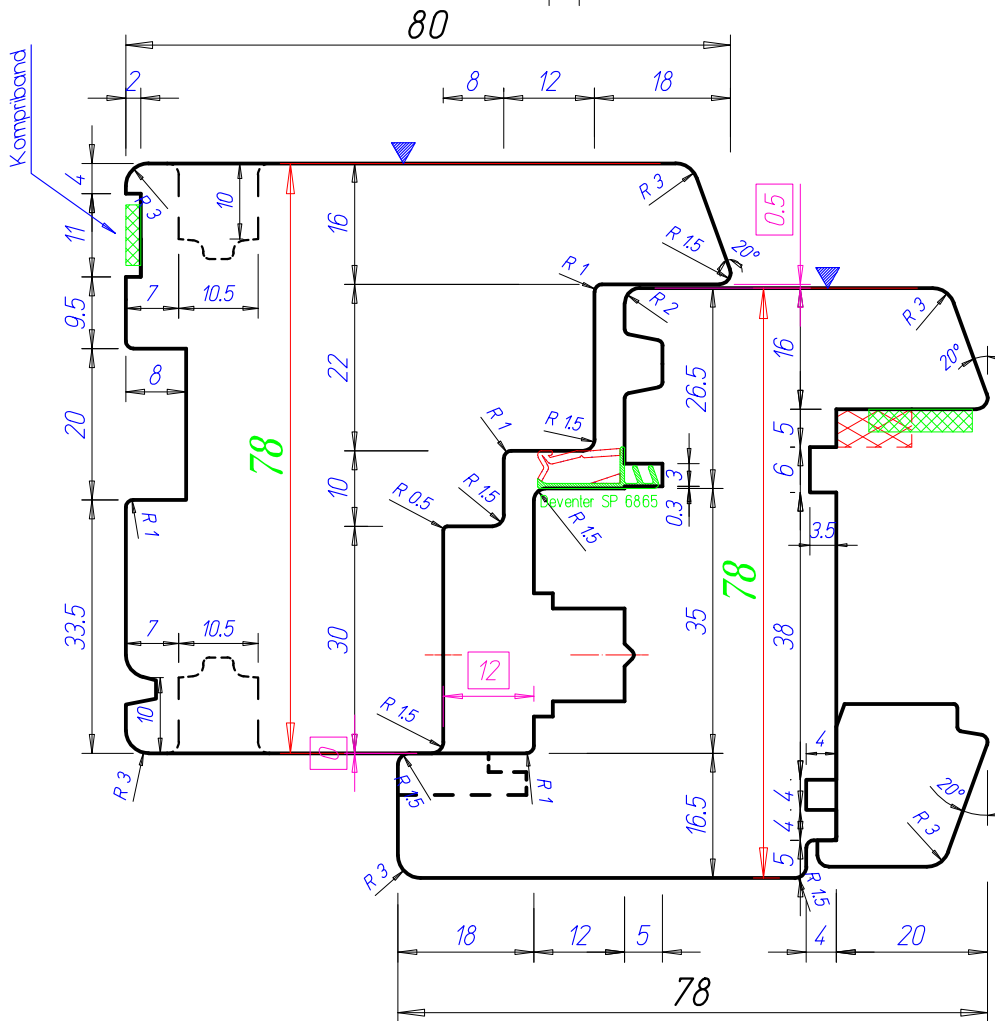
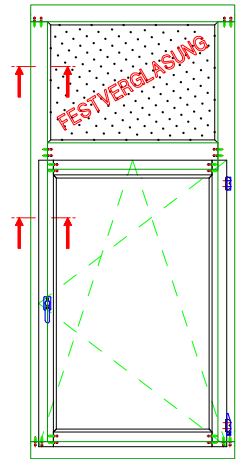
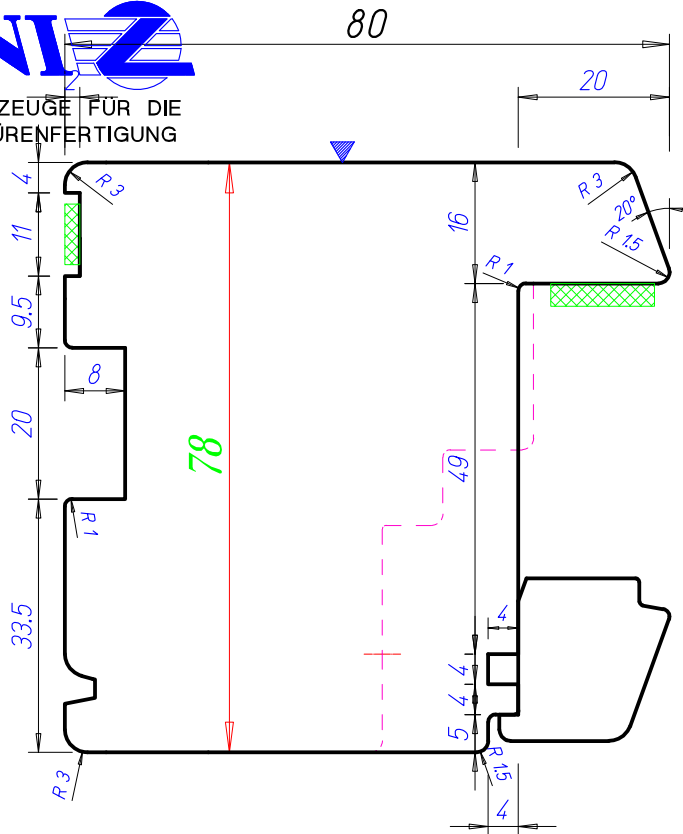

AUFLAGESEITE

WAAGERECHTER SCHNITT - ÜBERLICHT

Kunde		ZUANI DEUTSCHLAND rif. PAULI			
Title Fensterschnitt IV 78/78 - Eurofalz Achsmass 13 mm					
Revis.	A.P.	Date	15-05-2012	Scala	1:1
Verif.	M.Z.	Date	12-12-2011	Dis.	M.Z.
				Dis.	12-12-2011
				Codice Dis.N°	A7878D22.96

